

StepArray+

Self-powered digitally steerable column loudspeakers

User Manual

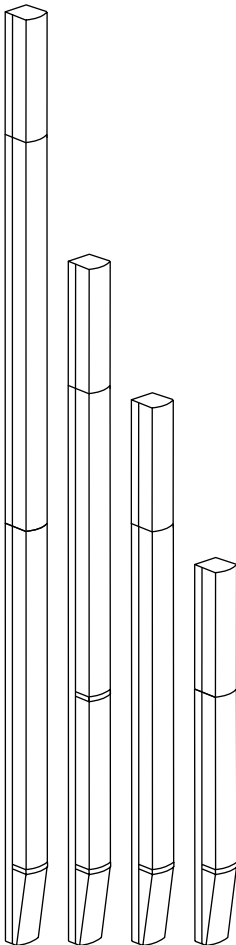

active
audio
L'acoustique active

Table of contents

1. Introduction.....	4
2. System components	5
3. Assembling	6
4. Wiring	7
4.1. Example setup using Dante®	7
5. StepArray+ control software.....	8
5.1. System requirements.....	8
5.2. Installation on Windows	8
5.3. Installation on OS X	9
5.4. Using the StepArray+ software	10
6. Installation of the columns.....	12
6.1. Dimensions of the brackets.....	13
7. Specifications	14
8. Acoustical data.....	16
8.1. Common data	16
8.2. SA100P / SA150P+ acoustical data ¹	17
8.3. SA180P / SA230P+ acoustical data ¹	18
8.4. SA250P / SA300P+ acoustical data ¹	19
8.5. SA400P / SA450P+ acoustical data ¹	20
8.6. SA180S / SA230S+ acoustical data ¹	21
8.7. SA250S / SA300S+ acoustical data ¹	22
9. Declaration of conformity	23

1. Introduction

StepArray+ column speakers ensure perfect speech intelligibility and optimal acoustic comfort, even in noisy and reverberant venues. They are based on the DGRC (Digital & Geometric Radiation Control) principle patented by Active Audio.

Compared with a classic sound system in which each loudspeaker is controlled independently, the DGRC method makes it possible to decrease the number of channels to be controlled, thereby enhancing economic efficiency.

StepArray+ also allows the use of existing network cables and helps to achieve significant savings in wiring, with up to 64 channels on a single Ethernet cable. StepArray+ combines the features of Dante™ and StepArray to achieve ever higher levels of efficiency and flexibility.

The StepArray+ range includes 6 models of column speakers, from 1.50m to 4.50m high.

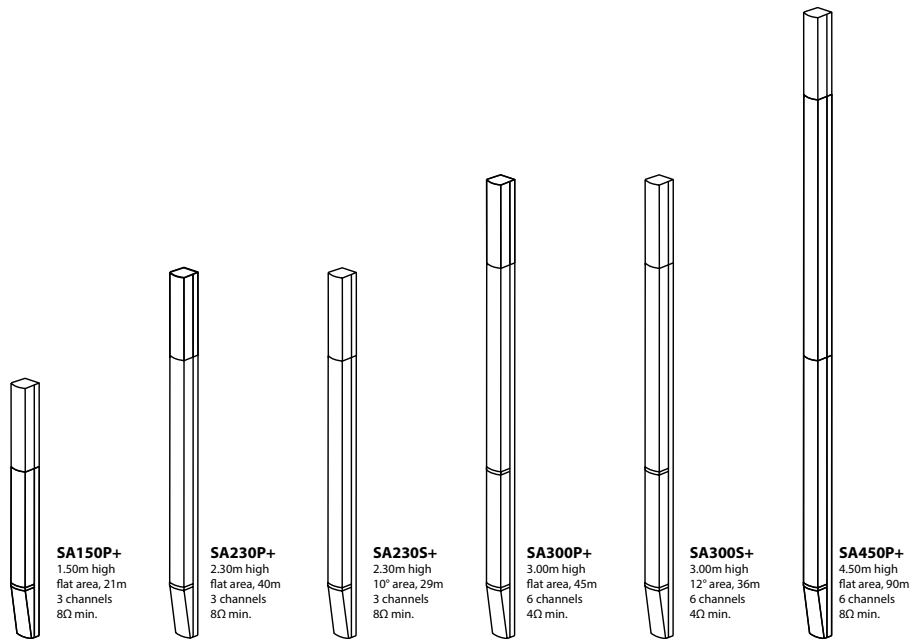

2. System components

StepArray+ columns are made of two parts: a standard StepArray passive column, and its companion StepArray+ amplifier module.

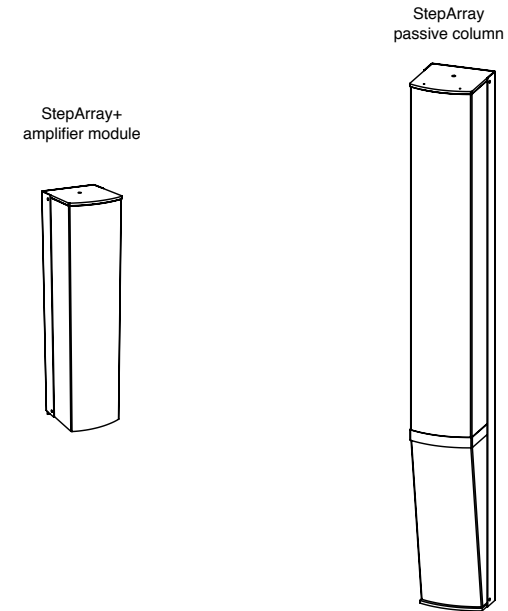

Figure 1 : System components

3. Assembling

1. Remove the back plate of the amplifier module.
2. Place the amplifier module at the top of the passive column.
3. Secure the amplifier module using the supplied M8 nut.
4. After wiring, close the connection box by mounting the back plate.

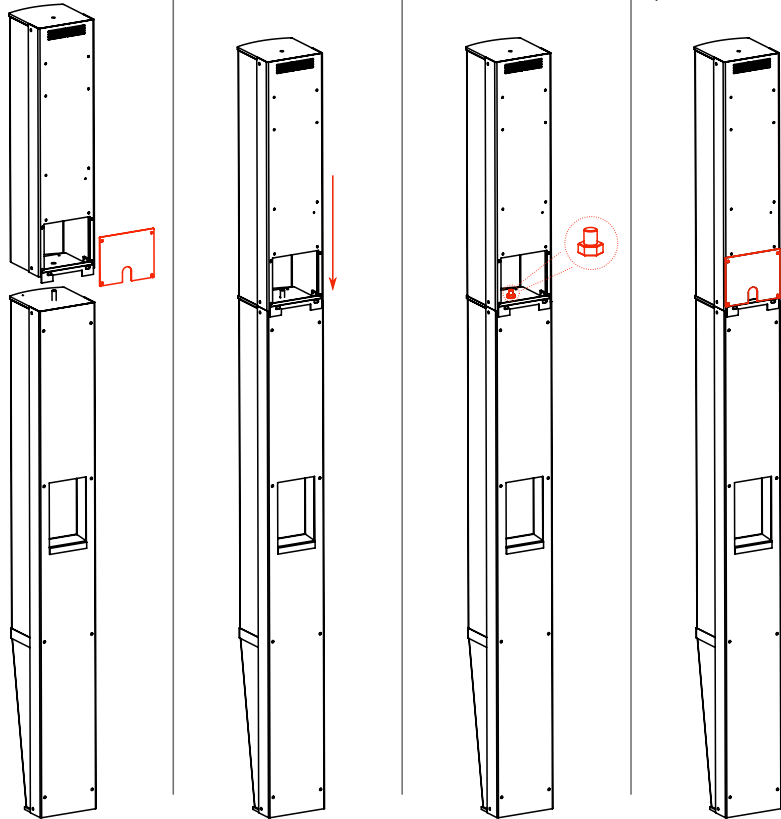

Figure 2 : Assembling StepArray+ columns

4. Wiring

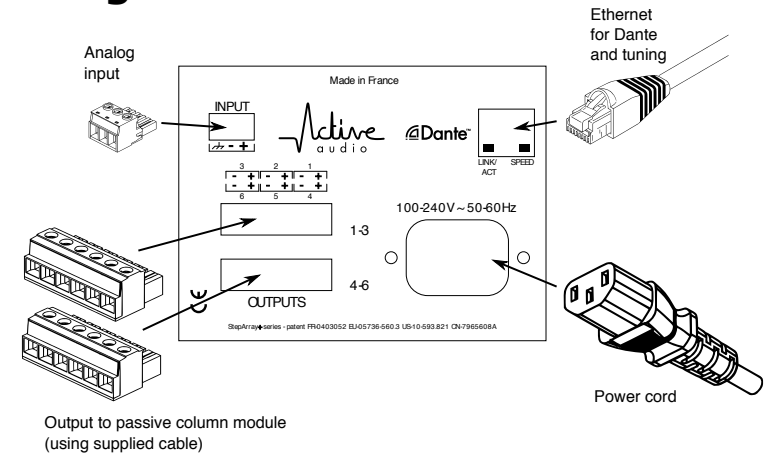

Figure 3 : Wiring StepArray+ columns

4.1. Example setup using Dante®

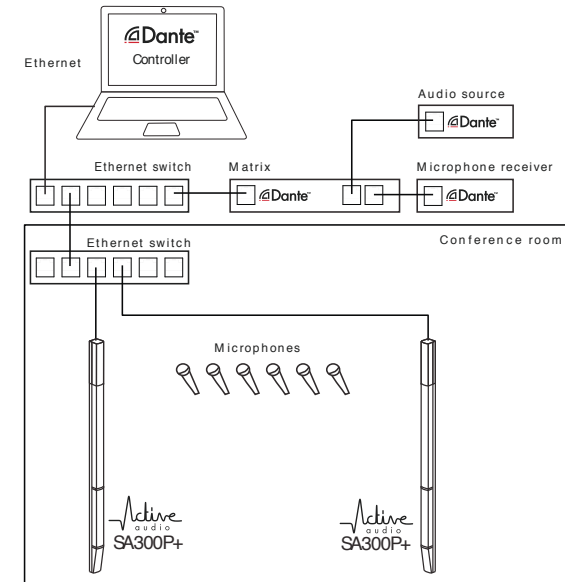

Figure 4 : StepArray+ setup using Dante network

5. StepArray+ control software

The StepArray+ control software is available for Windows and OSX operating systems. Installers can be found on the supplied USB key or on Active Audio's website by following this link: <http://www.activeaudio.fr/downloads>.

5.1. System requirements

Processor	1Ghz or better
Memory	512Mbyte of RAM
Network	Standard wired Ethernet network interface (100Mbps or Gigabit). Wireless LAN (Wi-Fi) Ethernet interfaces are not supported
Operating System	Windows 7 SP1 or newer Mac OS X 10.7.5 or newer

5.2. Installation on Windows

Start the installer package by double-clicking on it, then follow the instructions.

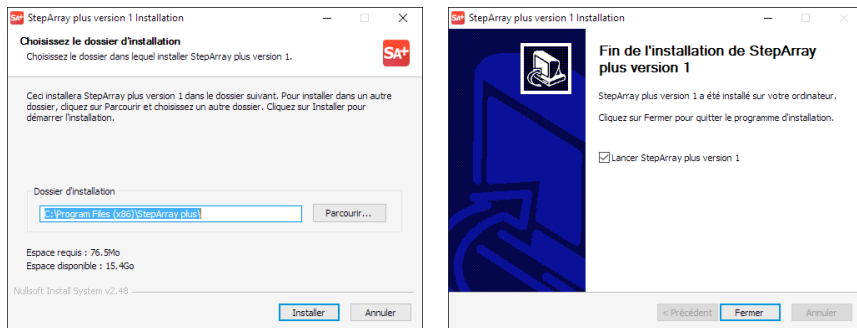

Figure 5 : StepArray+ Software installation on Windows

5.3. Installation on OS X

Start the installer package by double-clicking on it, then follow the instructions.

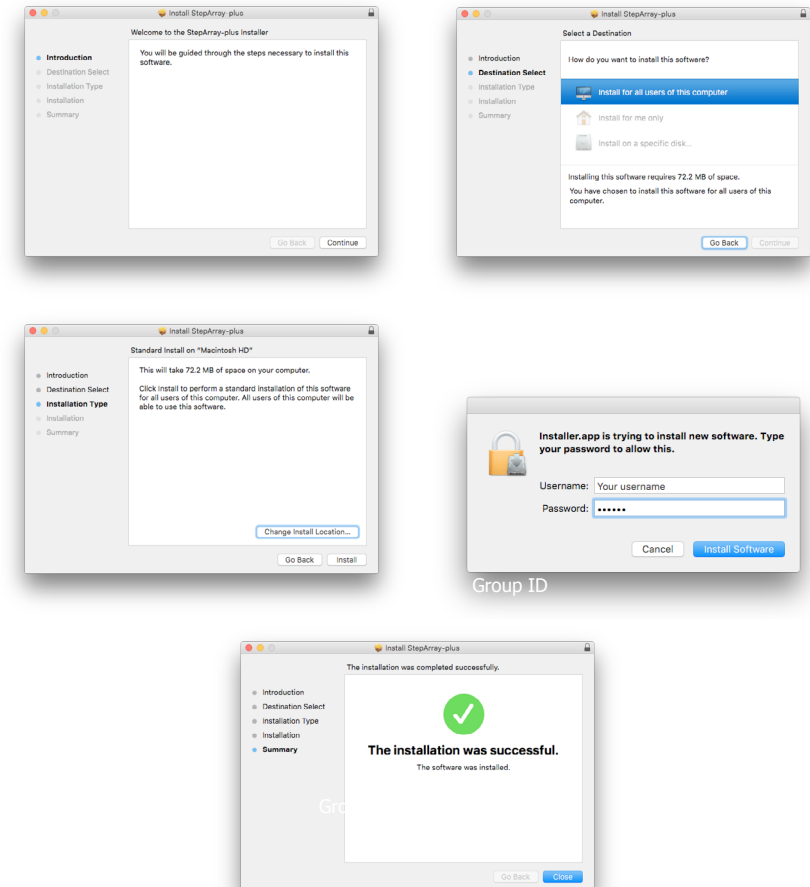

Figure 6 : StepArray+ Software installation on OS X

5.4. Using the StepArray+ software

The StepArray+ control software gives access to the following functions:

- input selection: Dante or analog input
- general output volume
- steering parameters for directivity control



The StepArray+ control software does not include Dante routing functionality. When using Dante to transmit audio, you will need the Dante Controller software to assign Dante channels to StepArray+ columns.

Dante Controller is available free of charge from the Audinate website: <https://www.audinate.com/products/software/dante-controller>.

When launching the StepArray+ control software, the first screen lists all the StepArray+ columns it can find on the network. The first connection to a StepArray+ column can take up to 1 minute: this is the time needed to initiate the communication.

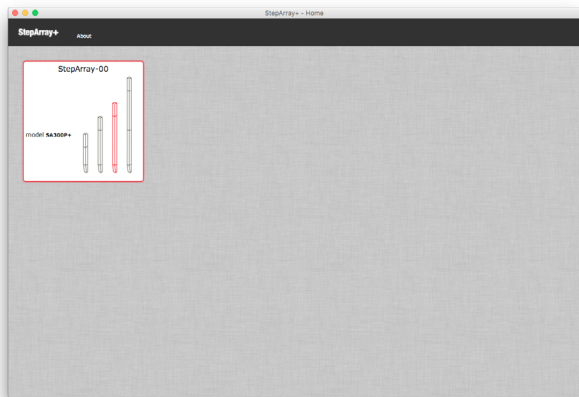

Figure 7 : StepArray+ control software: main screen

A click on a StepArray+ box leads to the settings screen of that specific column. All the parameters of the column can be changed within that screen.

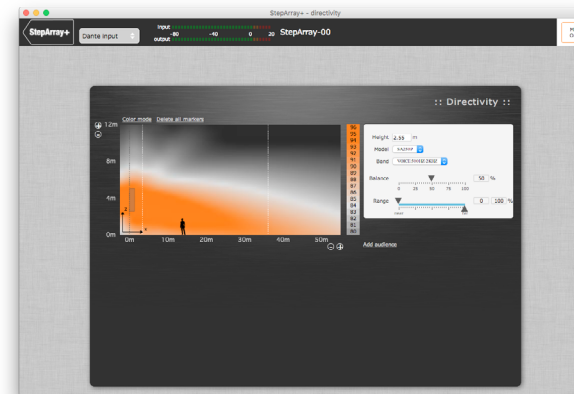

Figure 8 : StepArray+ control software: column settings screen

6. Installation of the columns

StepArray+ columns are mounted vertically, usually on a wall, using the supplied brackets. Figure 9 illustrates the steps to follow for column mounting. See also figure 10 on the next page for technical drawings of the brackets.

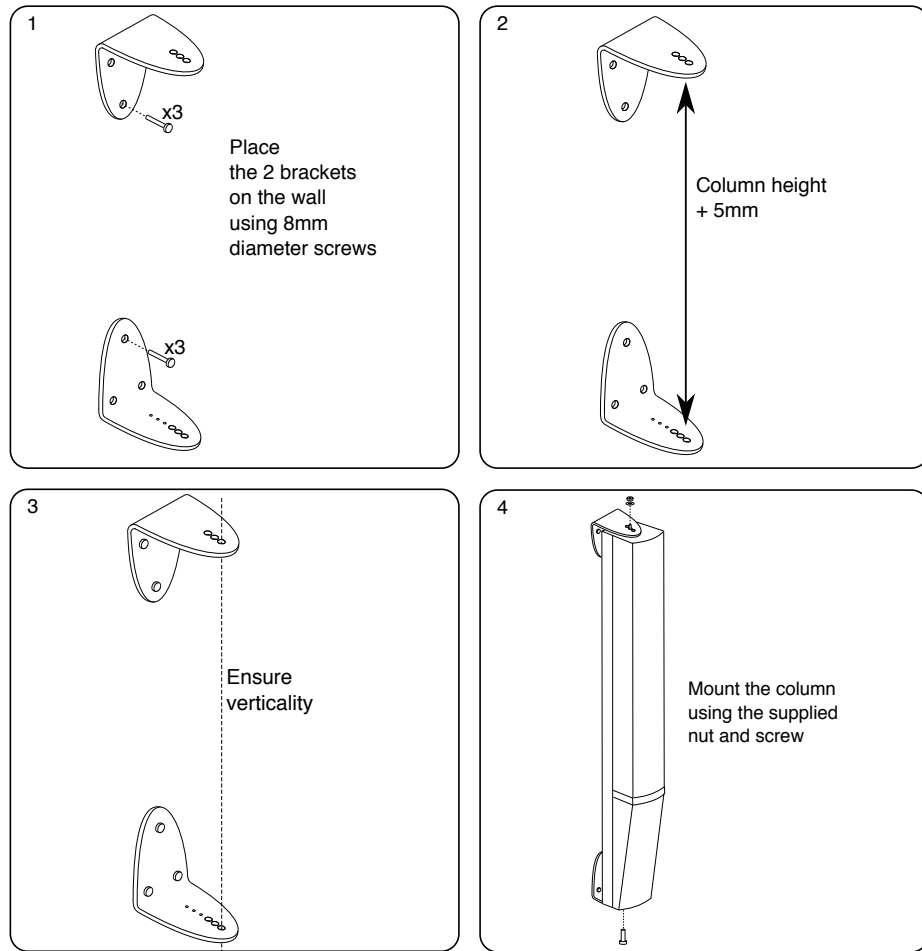

Figure 9 : Column mounting on a wall



It is important to ensure verticality when mounting StepArray+ columns.

6.1. Dimensions of the brackets

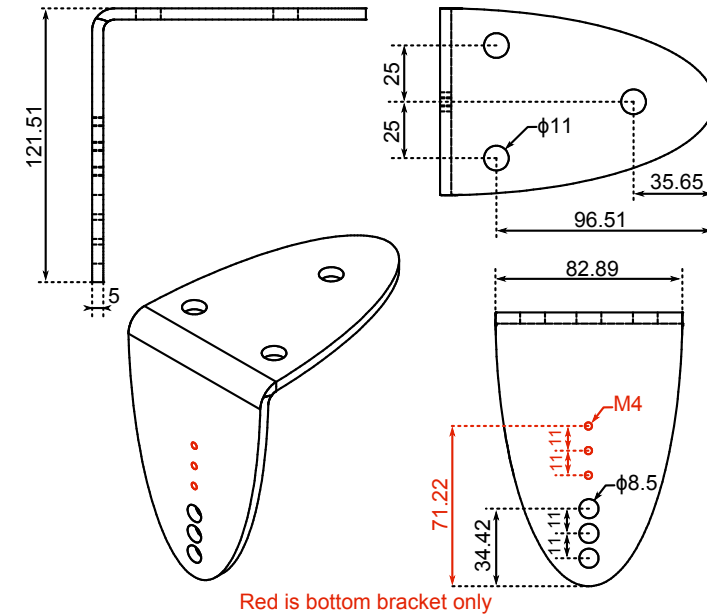

Figure 10 : Fixing brackets for wall mounting of StepArray columns

7. Specifications

SA150P+

Acoustical data		Electrical data	
range ±3dB	15m	max output power	450W
range ±5dB	21m	max continuous output power (25°)	300W
max SPL	95dB SPL at 10m	power consumption	Idle 22W
angle of audience	0°-5°		Typ. 80W
frequency bandwidth (-10dB)	110Hz-19kHz		Max 500W
horizontal opening angle	180°	number of Channels	3
		power supply	85-264VAC
			45-65Hz
Mechanical data		Inputs	
net weight	14 kg	1x balanced analog 3-pin input	
shipping weight	17 kg	1x Dante™ input	
height	1524mm		
width	124mm		
depth	131mm		
standard colors	white RAL 9016 black RAL 9005		
		Network	
		1x RJ45 connector, Dante™	
		max. operating ambient temperature	60°C

SA230P+

Acoustical data		Electrical data	
range ±3dB	30m	max output power	450W
range ±5dB	40m	max continuous output power (25°)	300W
max SPL	95dB SPL at 15m	power consumption	Idle 22W
angle of audience	0°-5°		Typ. 80W
frequency bandwidth (-10dB)	110Hz-19kHz		Max 500W
horizontal opening angle	180°	number of Channels	3
		power supply	85-264VAC
			45-65Hz
Mechanical data		Inputs	
net weight	22 kg	1x balanced analog 3-pin input	
shipping weight	24 kg	1x Dante™ input	
height	2340mm		
width	124mm		
depth	135mm		
standard colors	white RAL 9016 black RAL 9005		
		Network	
		1x RJ45 connector, Dante™	
		max. operating ambient temperature	60°C

SA230P+

Acoustical data		Electrical data	
range ±3dB	22m	max output power	450W
range ±5dB	29m	max continuous output power (25°)	300W
max SPL	95dB SPL at 15m	power consumption	Idle 22W
angle of audience	5°-20°		Typ. 80W
frequency bandwidth (-10dB)	110Hz-19kHz		Max 500W
horizontal opening angle	180°	number of Channels	3
		power supply	85-264VAC
			45-65Hz
Mechanical data		Inputs	
net weight	22 kg	1x balanced analog 3-pin input	
shipping weight	24 kg	1x Dante™ input	
height	2340mm		
width	124mm		
depth	135mm		
standard colors	white RAL 9016 black RAL 9005		
		Network	
		1x RJ45 connector, Dante™	
		max. operating ambient temperature	60°C

SA300P+

Acoustical data		Electrical data	
range ±3dB	35m	max output power	900W
range ±5dB	45m	max continuous output power (25°)	600W
max SPL	95dB SPL at 20m	power consumption	Idle 41W
angle of audience	0°-5°		Typ. 150W
frequency bandwidth (-10dB)	110Hz-19kHz		Max 1000W
horizontal opening angle	180°	number of Channels	6
		power supply	85-264VAC
			45-65Hz
Mechanical data		Inputs	
net weight	29 kg	1x balanced analog 3-pin input	
shipping weight	33 kg	1x Dante™ input	
height	3005mm		
width	124mm		
depth	159mm		
standard colors	white RAL 9016 black RAL 9005		
		Network	
		1x RJ45 connector, Dante™	
		max. operating ambient temperature	60°C

SA300S+

Acoustical data		Electrical data	
range ±3dB	28m	max output power	900W
range ±5dB	36m	max continuous output power (25°)	600W
max SPL	95dB SPL at 20m	power consumption	Idle 41W
angle of audience	5°-20°		Typ. 150W
frequency bandwidth (-10dB)	110Hz-19kHz		Max 1000W
horizontal opening angle	180°	number of Channels	6
		power supply	85-264VAC
			45-65Hz
Mechanical data		Inputs	
net weight	29 kg	1x balanced analog 3-pin input	
shipping weight	33 kg	1x Dante™ input	
height	3005mm		
width	124mm		
depth	159mm		
standard colors	white RAL 9016 black RAL 9005		
		Network	
		1x RJ45 connector, Dante™	
		max. operating ambient temperature	60°C

SA450P+

Acoustical data		Electrical data	
range ±3dB	68m	max output power	900W
range ±5dB	90m	max continuous output power (25°)	600W
max SPL	95dB SPL at 30m	power consumption	Idle 41W
angle of audience	0°-3°		Typ. 150W
frequency bandwidth (-10dB)	110Hz-19kHz		Max 1000W
horizontal opening angle	180°	number of Channels	6
		power supply	85-264VAC
			45-65Hz
Mechanical data		Inputs	
net weight	44 kg	1x balanced analog 3-pin input	
shipping weight	47 kg	1x Dante™ input	
height	4596mm		
width	124mm		
depth	135mm		
standard colors	white RAL 9016 black RAL 9005		
		Network	
		1x RJ45 connector, Dante™	
		max. operating ambient temperature	60°C

8. Acoustical data

All data presented below is obtained with columns in their nominal position and using nominal DSP filtering parameters (flat EQ, etc).

8.1. Common data

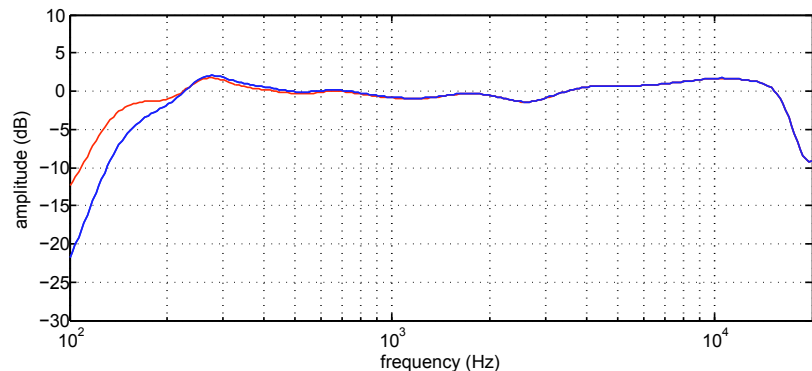

Figure 11 : Frequency response (column SA250P / SA300P+). Average of the measurements at 7, 10, 15, 20, 25, and 30m. In red: with bass high-pass on position «100Hz», in blue: with bass high-pass on position «200Hz».

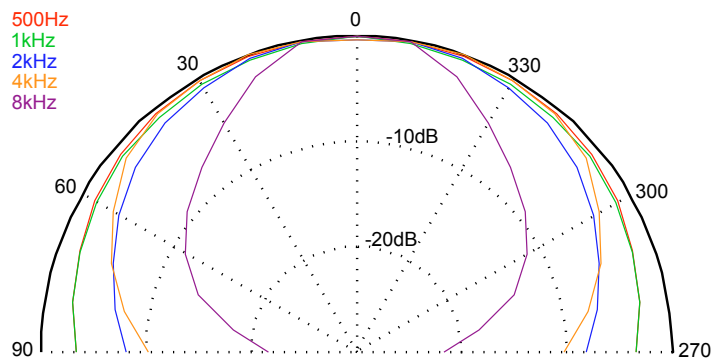

Figure 12 : Horizontal directivity (column SA250P/SA300P+)

8.2. SA100P / SA150P+ acoustical data¹

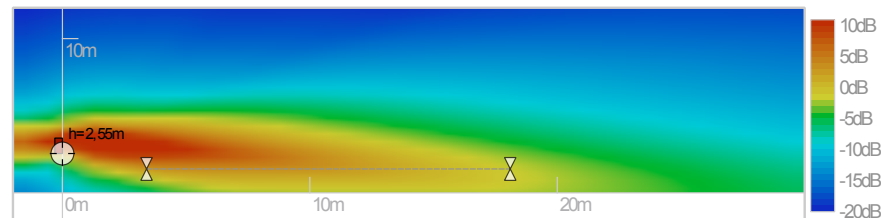

Figure 13 : SA100P / SA150P+ vertical directivity: sound level for the voice octaves (500Hz,1kHz,2kHz) in the vertical median plane

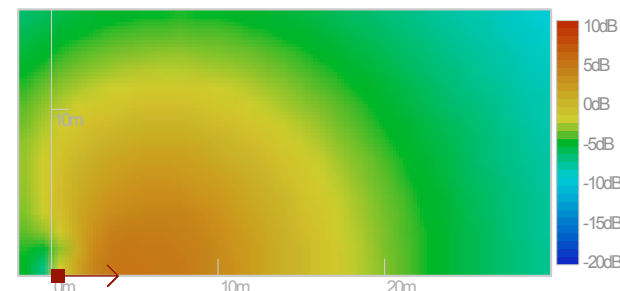

Figure 14 : SA100P / SA150P+ horizontal directivity: sound level for the voice octaves (500Hz,1kHz,2kHz) on the listening plane

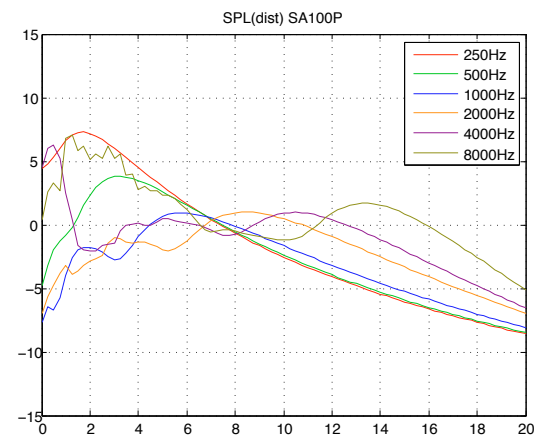

Figure 15 : Sound level by octave in the axis of the listening plane in front of the column with respect to the distance from the column

8.3. SA180P / SA230P+ acoustical data¹

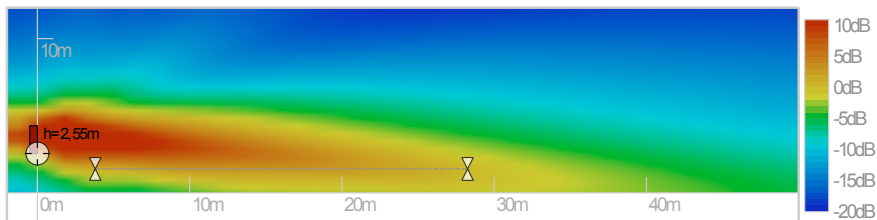

Figure 16 : SA180P / SA230P+ vertical directivity: sound level for the voice octaves (500Hz,1kHz,2kHz) in the vertical median plane

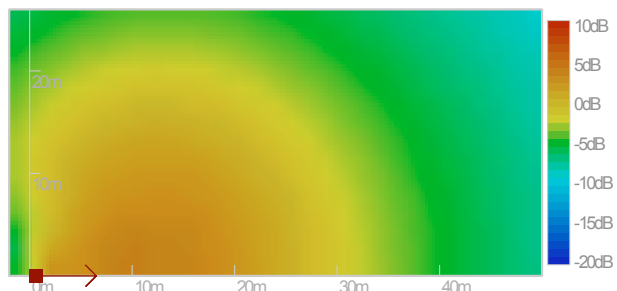

Figure 17 : SA180P / SA230P+ horizontal directivity: sound level for the voice octaves (500Hz,1kHz,2kHz) on the listening plane

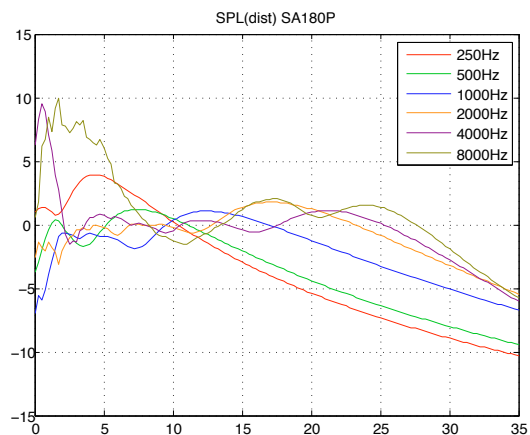

Figure 18 : Sound level by octave in the axis of the listening plane in front of the column with respect to the distance from the column

8.4. SA250P / SA300P+ acoustical data¹

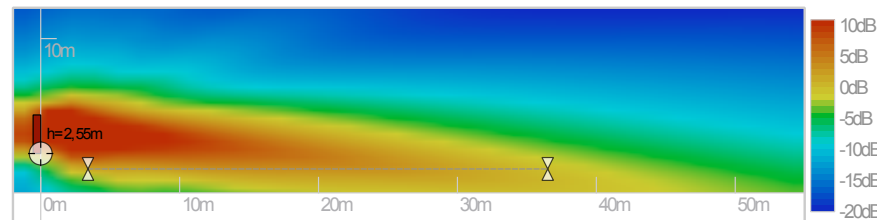

Figure 19 : SA250P / SA300P+ vertical directivity: sound level for the voice octaves (500Hz,1kHz,2kHz) in the vertical median plane

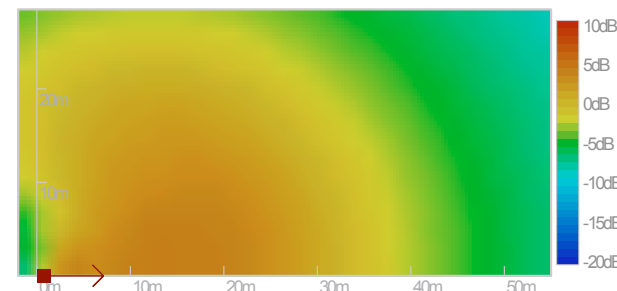

Figure 20 : SA250P / SA300P+ horizontal directivity: sound level for the voice octaves (500Hz,1kHz,2kHz) on the listening plane

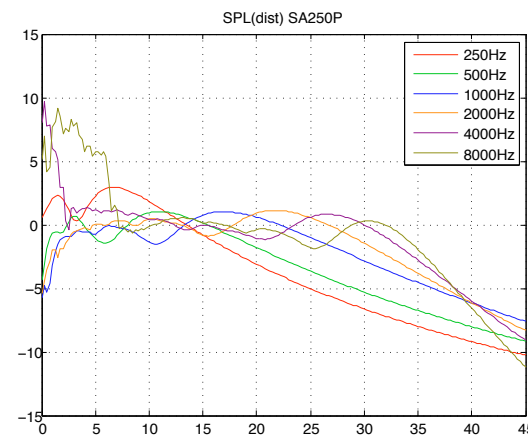

Figure 21 : Sound level by octave in the axis of the listening plane in front of the column with respect to the distance from the column

8.5. SA400P / SA450P+ acoustical data¹

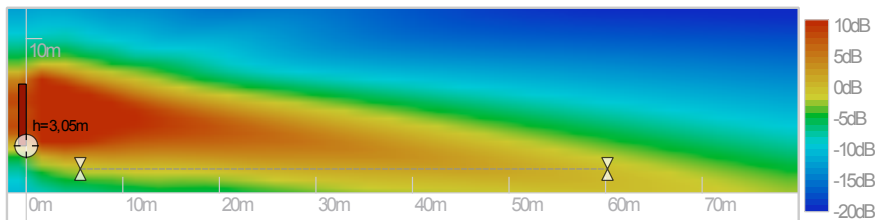

Figure 22 : SA400P / SA450P+ vertical directivity: sound level for the voice octaves (500Hz,1kHz,2kHz) in the vertical median plane

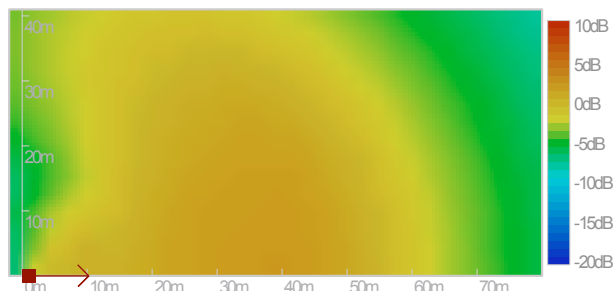

Figure 23 : SA400P / SA450P+ horizontal directivity: sound level for the voice octaves (500Hz,1kHz,2kHz) on the listening plane

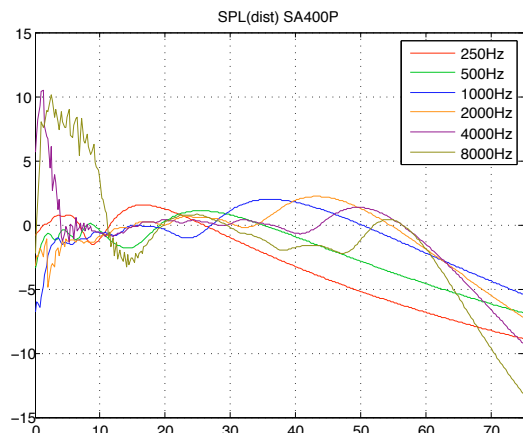

Figure 24 : Sound level by octave in the axis of the listening plane in front of the column with respect to the distance from the column

8.6. SA180S / SA230S+ acoustical data¹

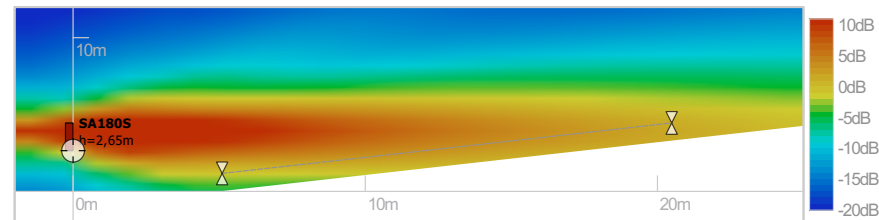

Figure 25 : SA180S / SA230S+ vertical directivity: sound level for the voice octaves (500Hz,1kHz,2kHz) in the vertical median plane

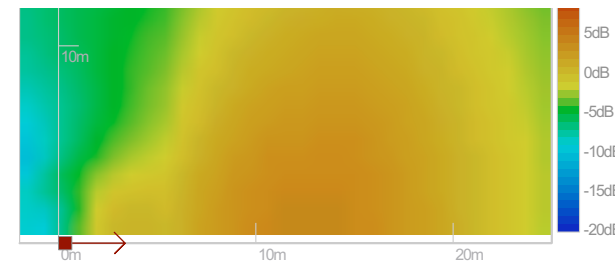

Figure 26 : SA180S / SA230S+ horizontal directivity: sound level for the voice octaves (500Hz,1kHz,2kHz) on the listening plane

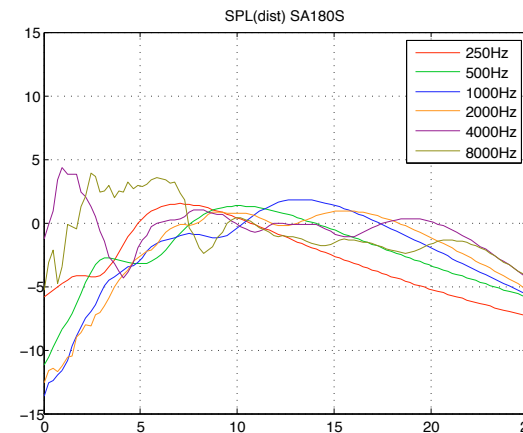

Figure 27 : Sound level by octave in the axis of the listening plane in front of the column with respect to the distance from the column

8.7. SA250S / SA300S+ acoustical data¹

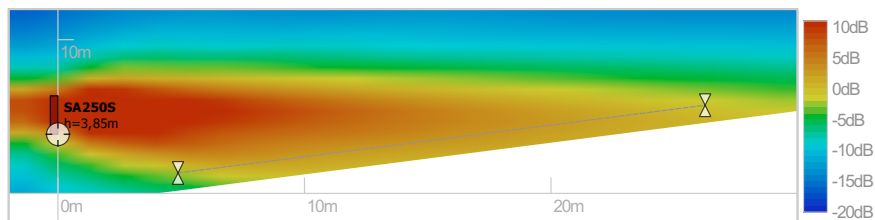

Figure 28 : SA250S / SA300S+ vertical directivity: sound level for the voice octaves (500Hz,1kHz,2kHz) in the vertical median plane

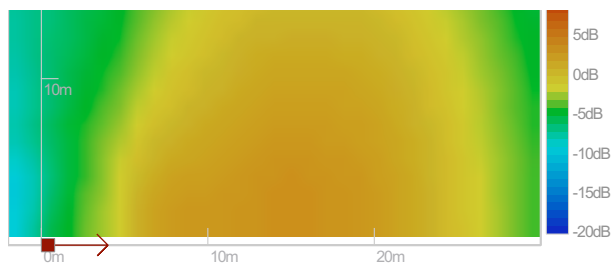

Figure 29 : SA250S / SA300S+ horizontal directivity: sound level for the voice octaves (500Hz,1kHz,2kHz) on the listening plane

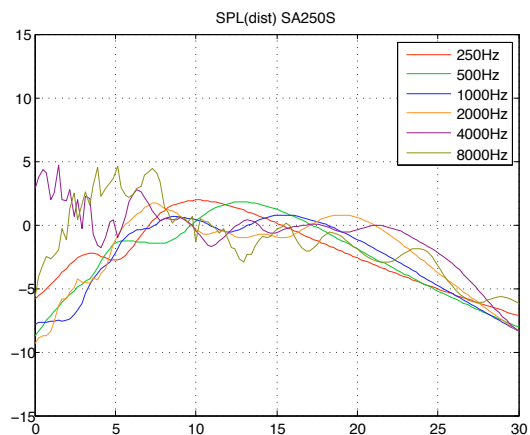

Figure 30 : Sound level by octave in the axis of the listening plane in front of the column with respect to the distance from the column

9. Declaration of conformity



We,
ACTIVE AUDIO SAS,
8 Rue Johannes Gutenberg 44340 , France,

Declares under our sole responsibility
that the following products

SA150P+, SA230P+, SA300P+, SA450P+,
SA230S+, SA300S+

comply with the council directive 2004/108/CE

Assessment of compliance is based on the following standards:
EN50081-1, EN61000, EN60065

Established on the 6th of January 2016
by Régis CAZIN, CEO.

www.activeaudio.fr
info@activeaudio.fr

Active Audio
8 Rue Johannes Gutenberg
44340 Bouguenais - France

Phone: +33 (0)2 404 666 64

Contact

