

article#	625-6x
article description	CEE-flanged plug 70x70 straight 32A 5p 6h IP44 black
description long	CEE-flanged plug 70x70 straight 32A 5p 6h IP44 black housing material: PA6 rated current: 32A number of poles: 5 (3P+N+PE) clock-position: 6h rated voltage/frequency: 200/346V~ - 240/415V~ / 50+60Hz contacts: brass connection technology: screw terminals dimensions (flange/fixing center): 70x70 mm / 56x56 mm IP protection class: IP44
GTIN (EAN)	9003399713880
country of origin	AT
customs number	85366990
net weight	0.166 kg
packaging quantity	10
minimum order quantity	10

ETIM 9.0	EC001319
IEC-amperage	32 A
Voltage according to EN 60309-2	400 V (50+60 Hz) red
Number of poles	5
Clock hour position	6 h
Identification colour	Red
Degree of protection (IP)	IP44
Connection system	Screwed terminal
Construction type	Built-up device plug
Angle of plug	Straight
Material	Plastic
Contact material	CuZn
Surface treatment contacts	Untreated

a	70 mm
b	70 mm
c	56 mm
d	56 mm
e	21 mm
f	51 mm
g	5,5 mm
h	55 mm
wire flexible	2,5-6 mm ²
wire solid	2,5-10 mm ²
contact screws	110 Ncm
dismantling length	50 mm
stripping length	12-14 mm
ambient temperature	-25 – 40 °C
temperature resistance	-25 – 80 °C

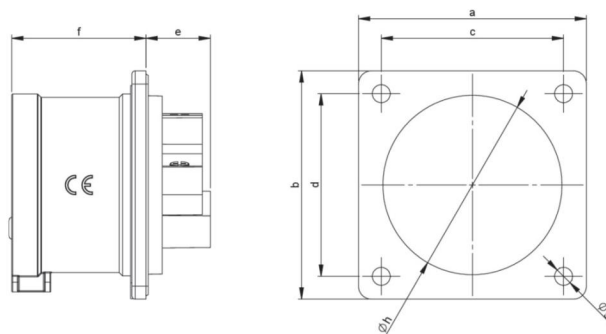





<https://www.pcelectric.at/shop/en/?func=detail&artnr=625-6x>

