

**INPUT PANEL**

- ① **1/4" INPUTS** - left and right stereo inputs for instruments.
- ② **RCA INPUTS** - left and right stereo inputs for -10dB consumer audio electronics.
- ③ **3.5mm TRS** - input connection for stereo -10dB consumer audio electronics.
- ④ **-15dB PAD** - reduces the input level by 15dB to prevent overload from high output devices.
- ⑤ **LIFT** - disconnects the transformer ground for the right channel only.

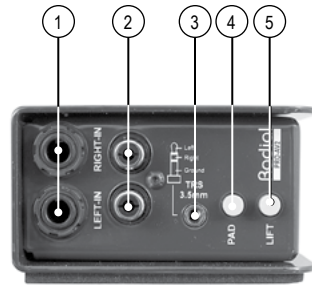

**OUTPUT PANEL**

- ⑥ **XLR OUTPUTS** - left and right balanced, mic-level outputs are 100% transformer-isolated.
- ⑦ **GROUND** - disconnects pin-1 on both XLR outputs to reduce noise caused by ground loops.

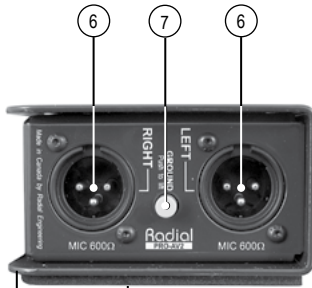

**CONSTRUCTION**

- ⑧ **BOOK-END DESIGN** - 14 gauge steel outer shell provides a protective zone for the switches and connectors.
- ⑨ **FULL BOTTOM PAD** - neoprene covers the entire bottom and provides electrical isolation and plenty of friction to stay put on hectic stages.
- ⑩ **WELDED I-BEAM CASE** - inner steel enclosure is made extremely rigid with I-beam profile. Eliminates stress that could torque the PCB and cause solder joint failure.
- ⑪ **MILITARY-GRADE** double-sided PCB is bolted to steel standoffs for toughness.
- ⑫ **RADIAL TRANSFORMER** - linear freq. response from 20Hz to 18KHz for natural sound. Mu-metal shield to eliminate electromagnetic interference.
- ⑬ **ISOLATED CONNECTORS** are made from extremely tough glass-filled nylon for true electrical isolation from chassis ground.

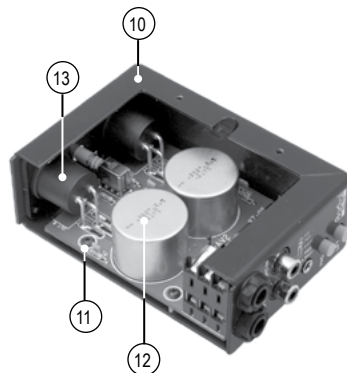

ProAV2 SPECIFICATIONS	
Frequency response	20Hz to 18kHz +/- 0.5dB
Total harmonic distortion	0.01% THD 20Hz to 20kHz
Stereo Inputs	Unbal. high-Z -10dB RCA, 1/4", and 3.5mm TRS
Outputs	Balanced 150-Ohm, mic-level, pin-2 hot
Input pad	-15dB
Power requirement	None, completely passive
Size	3.25" x 5" x 1.875"
Weight	1.8 lbs.

**RADIAL LIMITED THREE YEAR TRANSFERABLE WARRANTY**

Radial Engineering Ltd. ("Radial") warrants this product to be free from defects in material and workmanship and will remedy any such defects free of charge according to the terms of this warranty. Radial Engineering will repair or replace at its option any defective component(s) of this product, excluding the finish, the bottom foam pad and wear and tear from normal use, for a period of three (3) years from the original date of purchase. In the event that a particular product is no longer available, Radial Engineering reserves the right to replace the product with a similar product of equal or greater value. To make a request or claim under this limited warranty, the product must be returned prepaid in the original shipping container (or equivalent) to Radial Engineering or to an authorized repair centre and you must assume the risk of loss or damage. A copy of the original invoice showing date of purchase and the dealer name must accompany any request for work to be performed under this limited warranty. This limited warranty shall not apply if the product has been damaged due to abuse, misuse, misapplication, accident or as a result of service or modification by any other than an authorized repair centre.

THERE ARE NO EXPRESSED WARRANTIES OTHER THAN THOSE ON THE FACE HEREOF AND DESCRIBED ABOVE. NO WARRANTIES, WHETHER EXPRESSED OR IMPLIED, INCLUDING BUT NOT LIMITED TO, ANY IMPLIED WARRANTIES OF MERCHANTABILITY OR FITNESS FOR A PARTICULAR PURPOSE, SHALL EXTEND BEYOND THE RESPECTIVE WARRANTY PERIOD DESCRIBED ABOVE OF THREE YEARS. RADIAL ENGINEERING SHALL NOT BE RESPONSIBLE OR LIABLE FOR ANY SPECIAL, INCIDENTAL OR CONSEQUENTIAL DAMAGES OR LOSS ARISING FROM THE USE OF THIS PRODUCT. THIS WARRANTY GIVES YOU SPECIFIC LEGAL RIGHTS, AND YOU MAY ALSO HAVE OTHER RIGHTS, WHICH MAY VARY DEPENDING ON WHERE YOU LIVE.

**ProAV2 Stereo Direct Box Users Guide**



Radial Engineering Ltd.  
1845 Kingsway Ave., Port Coquitlam, BC V3C 0H3, Canada  
Tel: 604-942-1001 • Fax: 604-942-1010  
email: info@radialeng.com

Radial ProAV2 users guide v2.4 - Part #: R870 1145 00 / 07-2025  
Subject to change without notice

www.radialeng.com

## CONGRATULATIONS

on your purchase of the Radial ProAV2. Radial products are easy to use and this short manual contains all the information you need to start using your ProAV2 right away. For more information on the ProAV2, and other Radial products, visit our website, [www.radialeng.com](http://www.radialeng.com).

## OVERVIEW

The Radial ProAV2 is a two channel passive direct box. This innovative DI features a 'Swiss army knife' of input options making it the perfect DI for professional AV integrators and rental companies that regularly deal with a variety of system interface problems.

The Radial ProAV2 is equipped with standard 1/4" instrument inputs for each channel making it easy to connect stereo instruments or two mono ones. Stereo RCA and 3.5mm jacks allow for easy connections from consumer -10dB audio devices, like MP3 and CD players, to microphone snakes.

At the heart of the ProAV2 are two custom Radial transformers that convert the high impedance inputs to a balanced low impedance signal while isolating noise caused by ground loops. Constructed with a two piece 14 gauge steel enclosure the ProAV2 is well suited for years of touring and rental use. Enjoy!

## CONNECTING THE ProAV2

Before connecting the ProAV2 make sure the sound system is turned off and all levels are set to zero. This will avoid any pops in the sound system that could damage loudspeakers. Also confirm that the GROUND, PAD and LIFT buttons are in their "out" positions. The ProAV2 is passive and does not require any power whatsoever to work. Phantom power will not damage the ProAV2 if applied.

## ProAV2 BLOCK DIAGRAM

Follow the block diagram from the inputs on the left to the outputs on the right. A really cool feature with the ProAV2 is all the input jacks are paralleled together in stereo. This makes any hi-Z jack a handy patch point. For example, a CD player may be connected to the RCA jacks and the signal sent to a computer sound card via the 3.5mm jack in addition to the balanced XLR outputs.

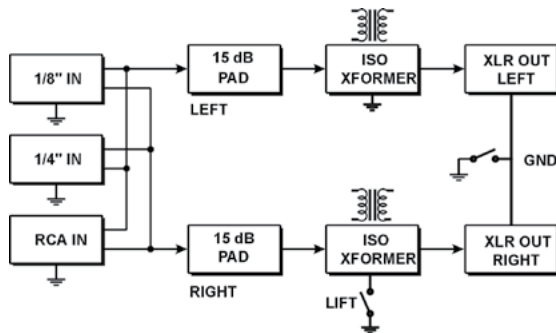

## 1/4" INSTRUMENT JACKS

Stereo devices like keyboards and drum machines connect to the left and right 1/4" jacks. Mono musical instruments may be connected to one channel using either 1/4" input and the like XLR output.

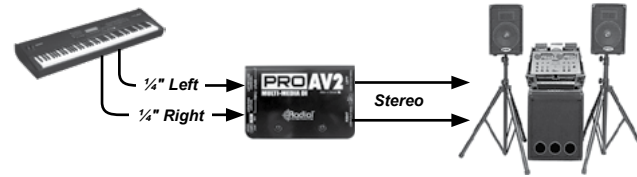

## RCA & 3.5mm JACKS

Stereo consumer electronics like CD and MP3 players connect directly to the ProAV2 without cumbersome adaptors using the stereo RCA and 3.5mm jacks.

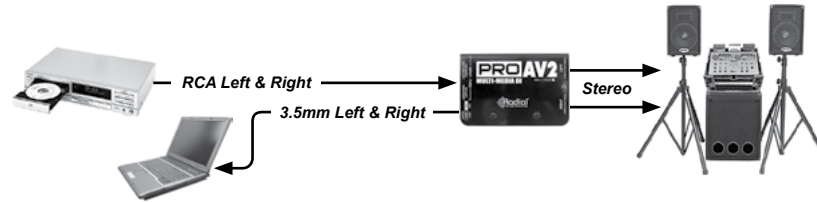

## -15dB PAD

The ProAV2 is equipped with a -15dB input PAD to prevent overload distortion when interfacing high output devices like CD players. The PAD reduces the input level going to the left and right transformers.

## TRANSFORMER ISOLATION

The ProAV2 transformers convert the hi-Z inputs to balanced, low-Z, mic-level outputs. A major benefit of using transformers for signal conversion is the isolation the transformer provides. Transformer isolation effectively blocks hum and buzz caused by ground loops by preventing the flow of stray DC current between the input ground and output ground.

Radial transformers are custom manufactured for optimum signal transfer, minimal insertion loss and flat frequency response. They are exceptional for their ability to handle high input levels with very low harmonic and phase distortion. To make the ProAV2 as quiet as possible, we sealed the transformer inside a can made of mu-metal. Mu-metal is known for its ability to block electromagnetic interference.

## GROUNDING OPTIONS

To make grounding as flexible as possible and eliminate noise caused by ground loops, the ProAV2 features two ground lift functions. The first, labeled GROUND, is located on the output panel with the XLR connectors. It is a global ground lift intended for stereo applications and will disconnect pin-1 on both XLR outputs.

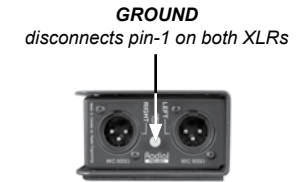

The second ground lift is simply labeled LIFT and is located on the input panel. This switch allows the right channel ground to be lifted separately from the left channel and is intended for dual mono applications where one source device needs a ground path through the ProAV2 while the other may not. Note that the GROUND switch supersedes the LIFT switch and disconnects the ground path for both channels regardless of the position of the LIFT switch.

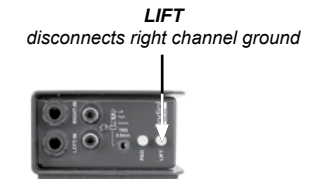

## XLR OUTPUT

Each ProAV2 channel outputs a balanced, mic-level signal that is compatible with microphone snakes and mixing console preamps. The output can drive long cables without appreciable noise or signal loss.

## OPTIONAL J-RAK

The optional J-RAK is a high density 2RU rack shelf for Radial DI's and splitters that allows up to 8 Radial devices to mount in one neat 19" package. Ideal for studio or touring. Constructed of 14 gauge steel with a baked enamel finish.



## OPTIONAL J-CLAMP

The optional J-CLAMP can mount a single Radial device to virtually any surface. Perfect for hiding away inside racks, on podiums or under tables.

